

WS

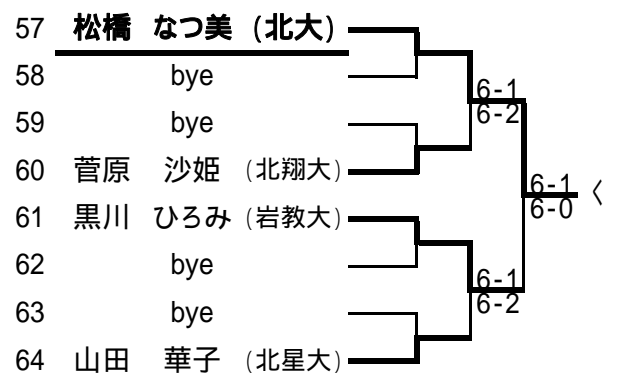

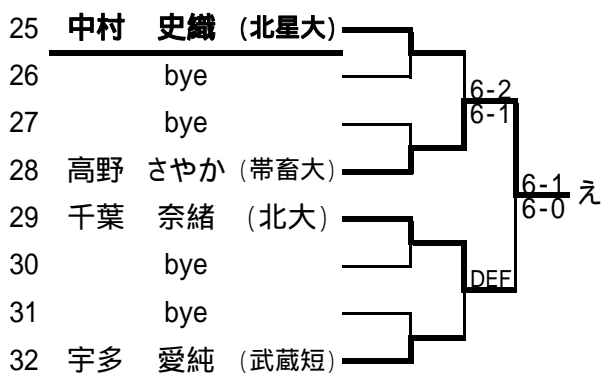

1R 2R 3R

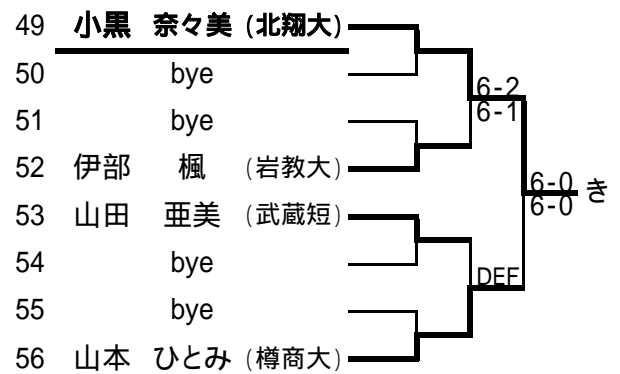
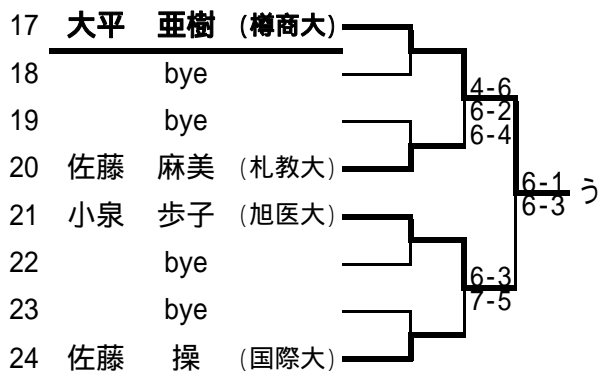
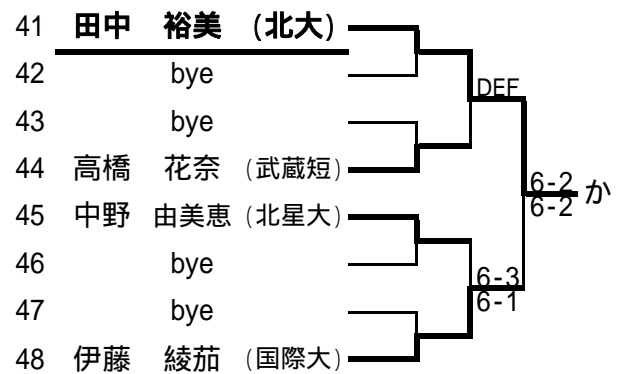
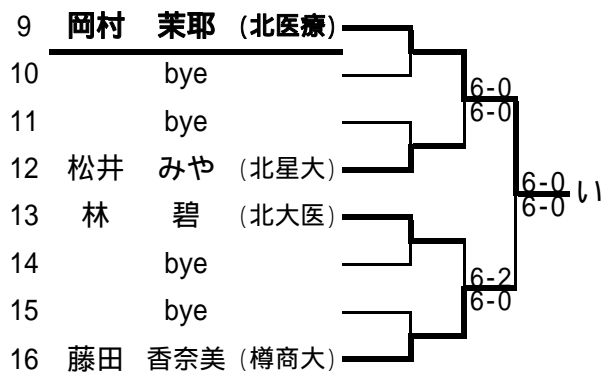
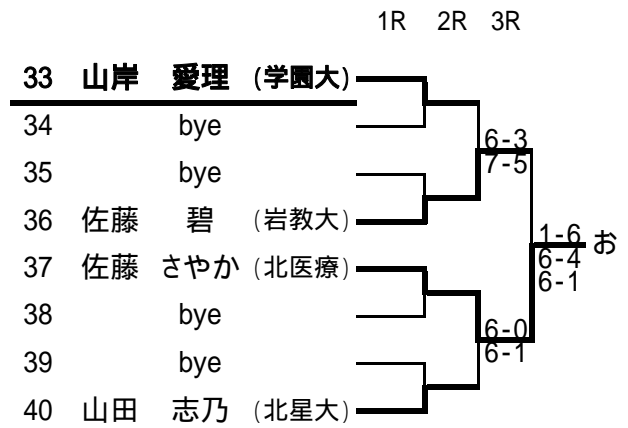
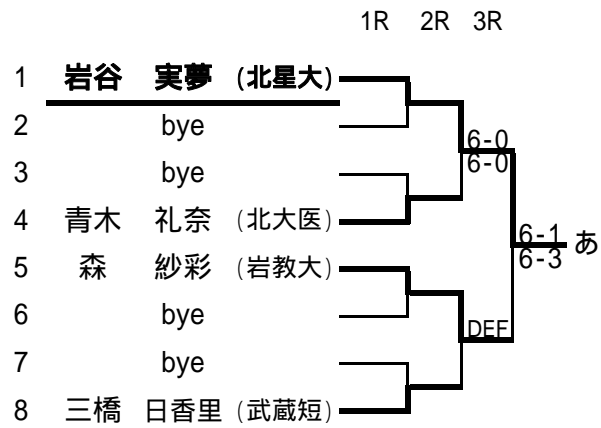
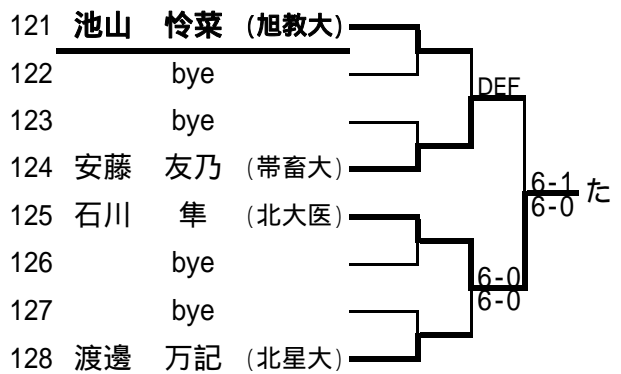
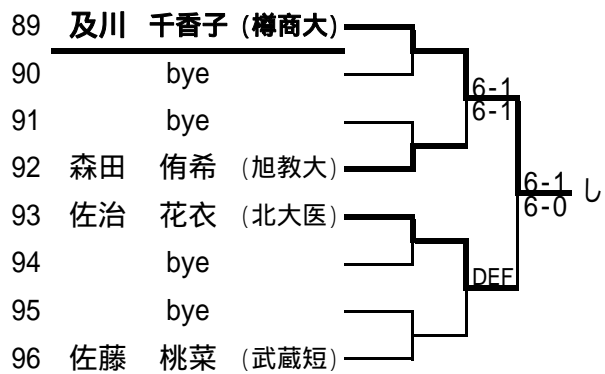
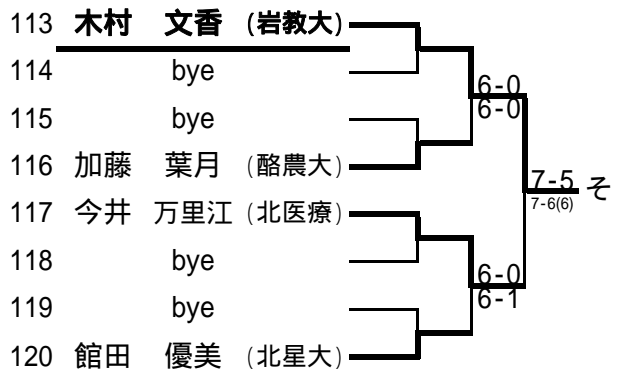
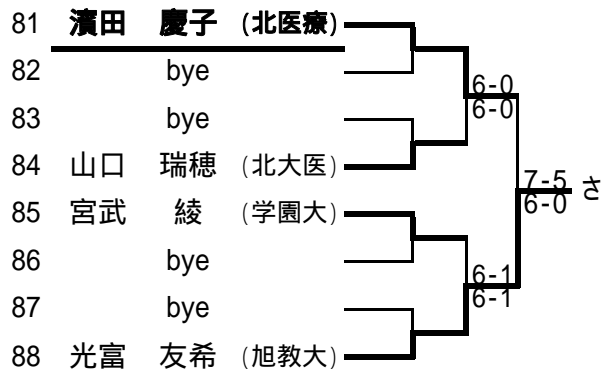
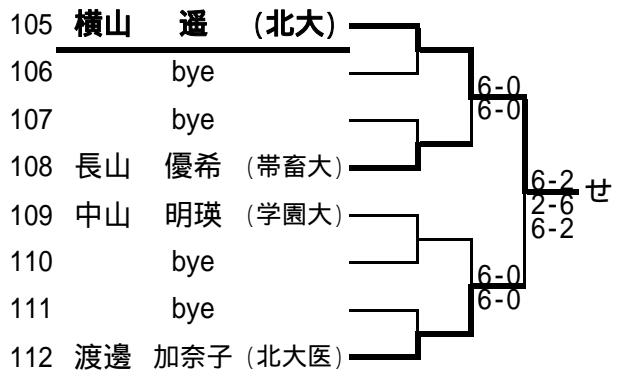
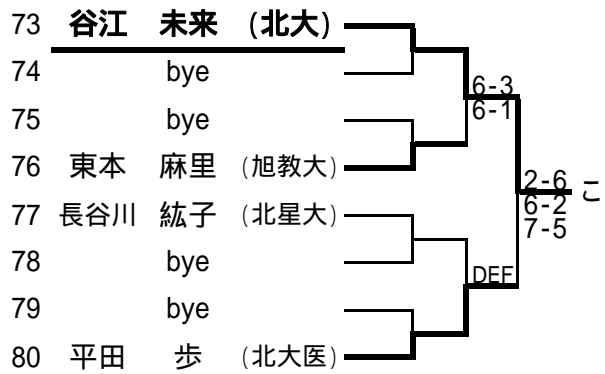
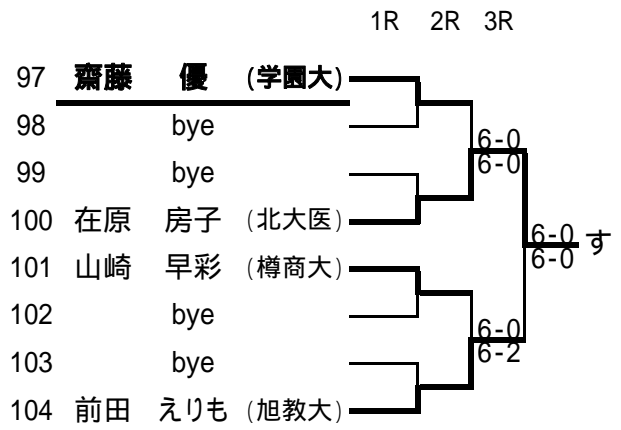
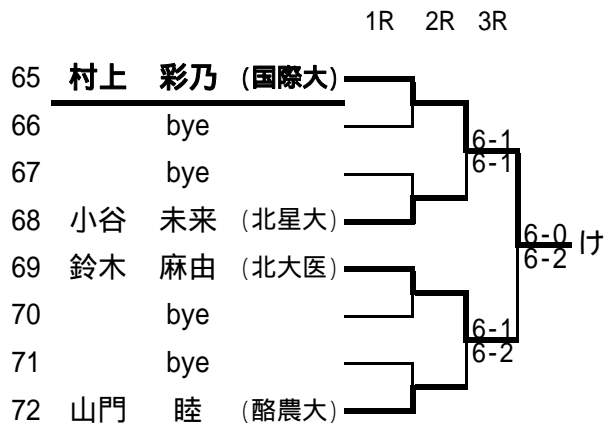