

# MD

1R 2R 3R

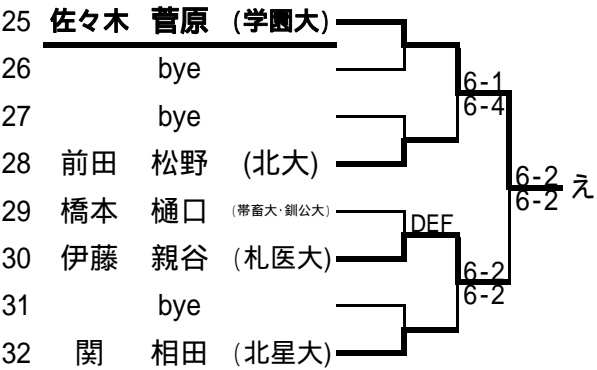

1R 2R 3R

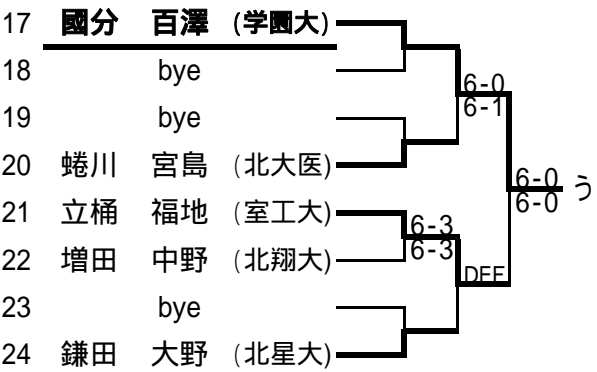
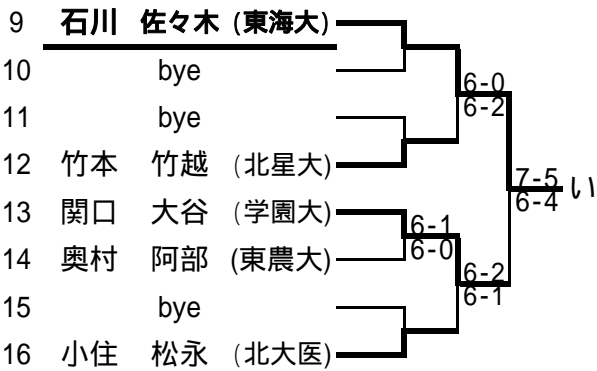
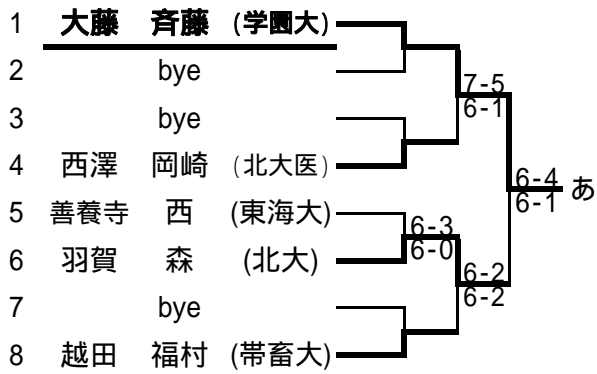
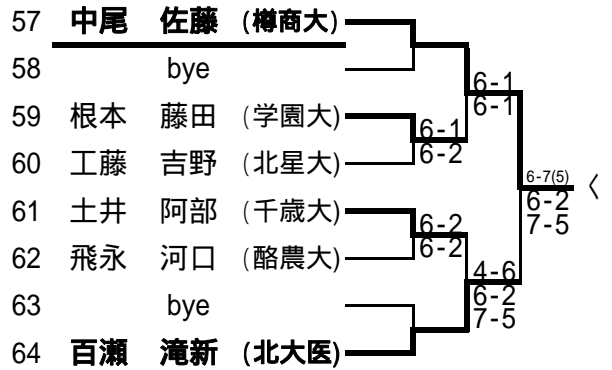
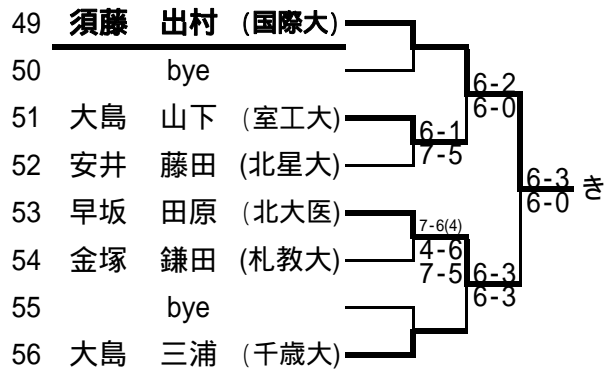
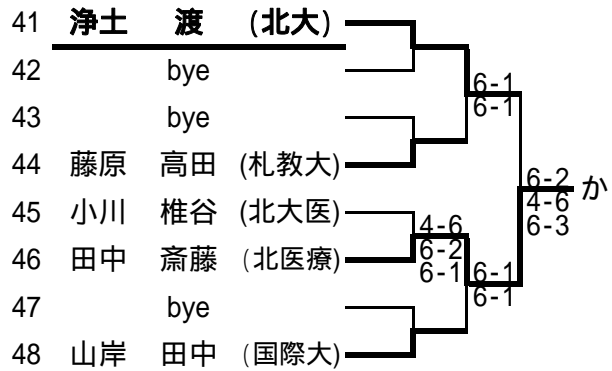
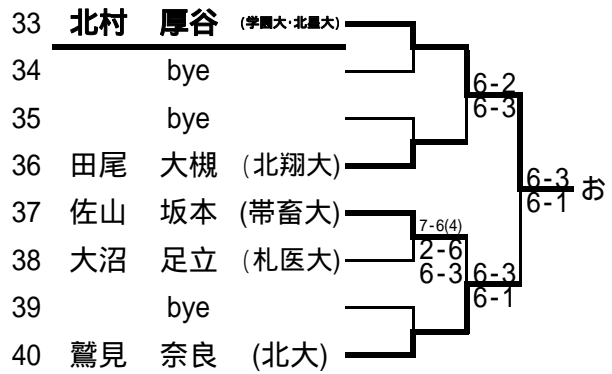

1R 2R 3R

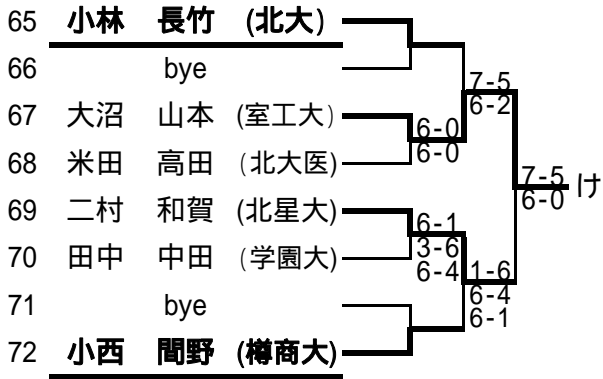

1R 2R 3R

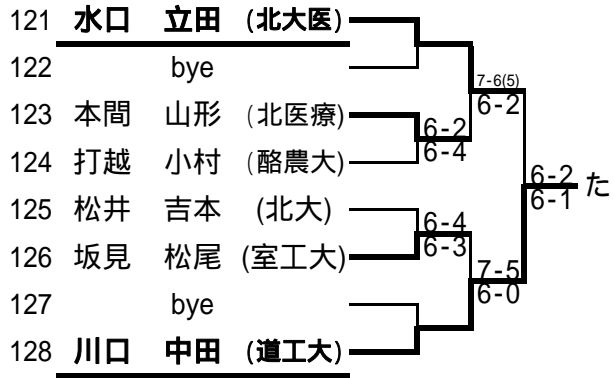
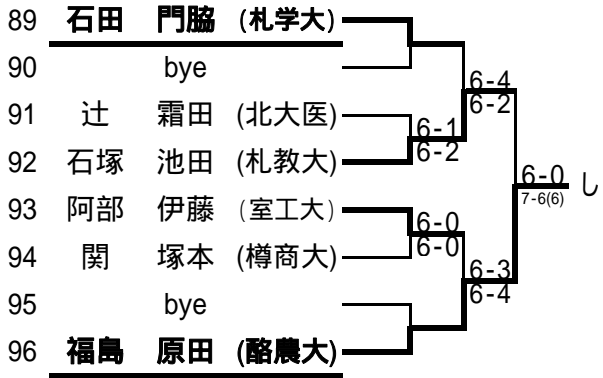
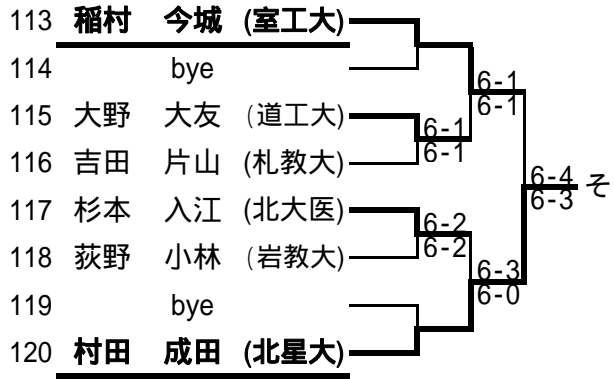
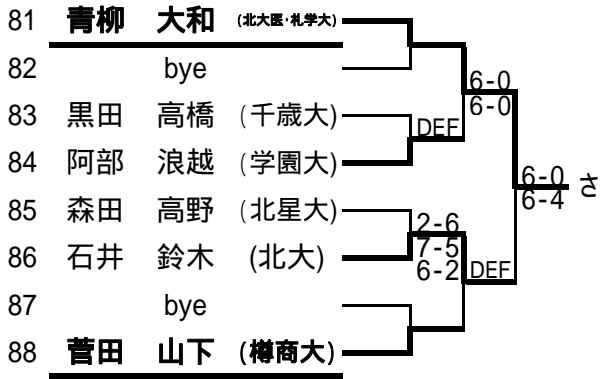
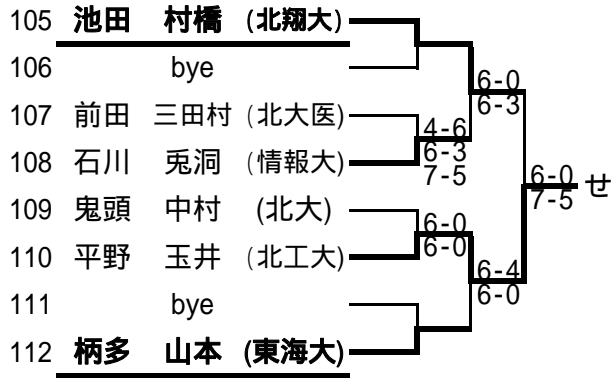
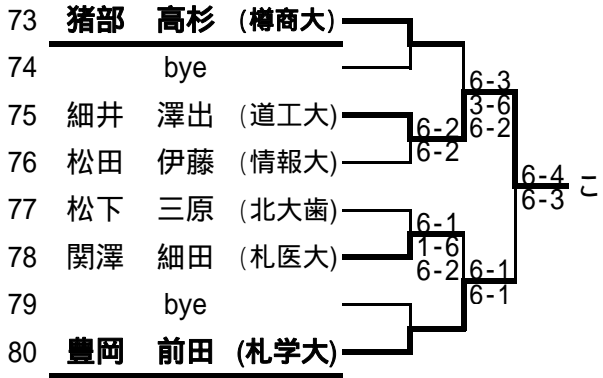
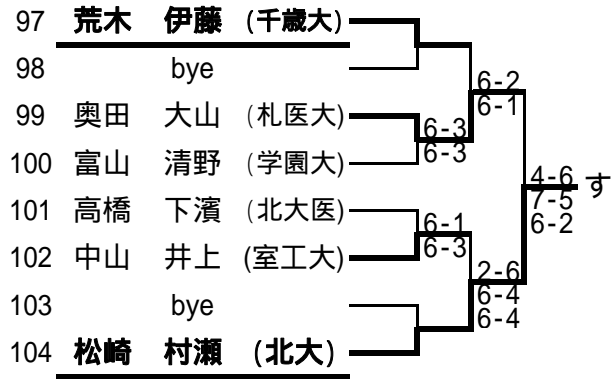

1R 2R 3R

